

# Flymo

 Electrolux

## ROLLER COMPACT 400/4000

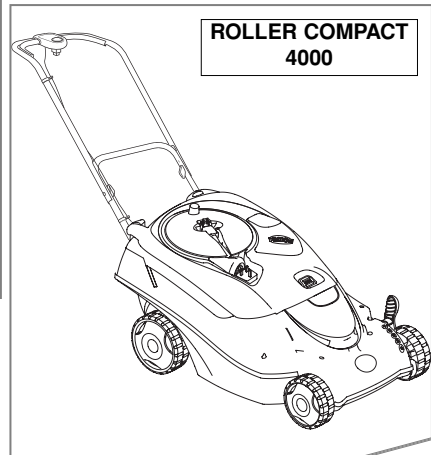
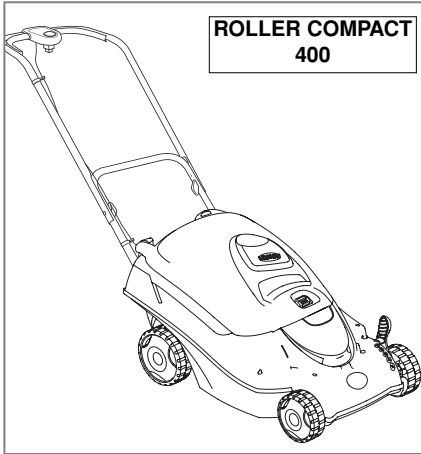

**IMPORTANT INFORMATION**  
Read before use  
& retain for future reference



For all customer enquiries or for replacement parts, contact:-

 01325 300303

 [www.flymo.com](http://www.flymo.com)

 [eop.customer.services@electrolux.co.uk](mailto:eop.customer.services@electrolux.co.uk)

## Carton Contents

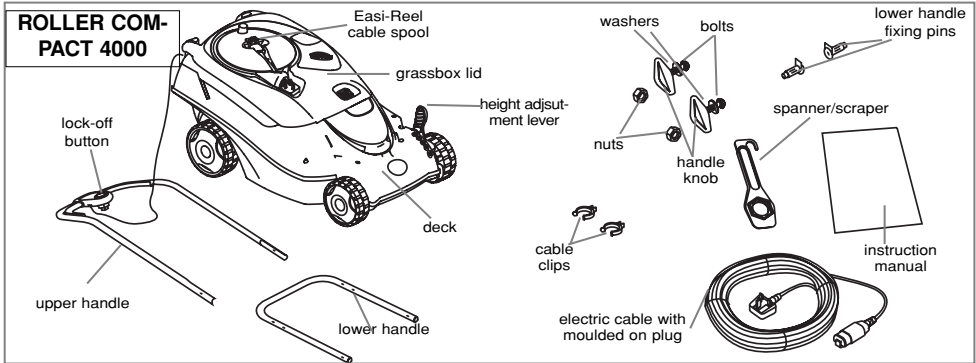
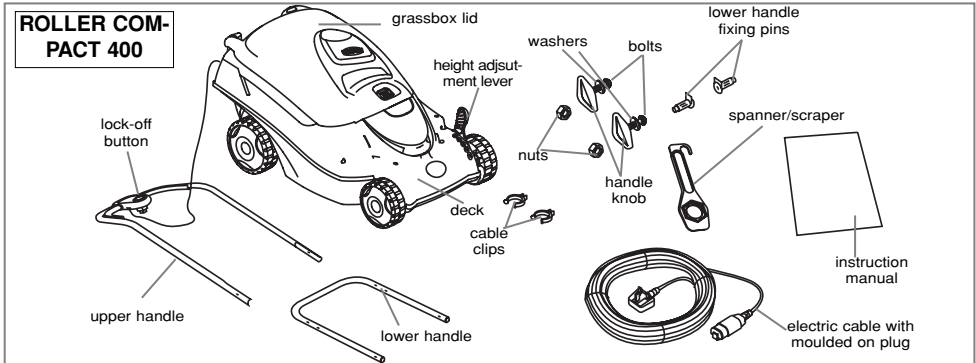

**IMPORTANT !** Please check the contents of the carton are correct **BEFORE** assembling your new Flymo product. **IF ANY PARTS ARE MISSING CONTACT:-**

Electrolux Outdoor Products Customer Service Department direct  
Telephone : 01325 300303, Fax : 01325 318193

## Safety



If not used properly this lawnmower can be dangerous! This lawnmower can cause serious injury to the operator and others, the warnings and safety instructions must be followed to ensure reasonable safety and efficiency in using this lawnmower. The operator is responsible for following the warning and safety instructions in this manual and on the lawnmower. Never use the mower unless the grass-box or guards provided by the manufacturer are in the correct position.

### Explanation of Symbols on the Roller Compact 400/4000



Warning



Read the user instructions carefully to make sure you understand all the controls and what they do.



Always keep the lawnmower on the ground when mowing. Tilting or lifting the lawnmower may cause stones to be thrown out



Keep bystanders away. Do not mow whilst people especially children or pets are in the mowing area



Switch off! Remove plug from mains before adjusting, cleaning or if cable is entangled or damaged. Keep the cable away from the blade.



Beware of severing toes or hands. Do not put hands or feet near a rotating blade.



Blade continues to rotate after the machine is switched off. Wait until all machine components have completely stopped before touching them.



Do not mow in the rain or leave the lawnmower outdoors while raining



**(RC4000 only)**  
Unwind and remove fully before use.

## General

1. Never allow children or people unfamiliar with these instructions to use the mower. Local regulations may restrict the age of the operator.
2. Only use the lawnmower in the manner and for the functions described in these instructions.
3. Never operate the lawnmower when you are tired, ill or under the influence of alcohol, drugs or medicine.
4. The operator or user is responsible for accidents or hazards occurring to other people or their property.

## Electrical

1. The British Standards Institute recommend the use of a Residual Current Device (R.C.D.) with a tripping current of not more than 30mA. Even with a R.C.D. installed 100% safety cannot be guaranteed and safe working practice must be followed at all times. Check your R.C.D. every time you use it.
2. Before use, examine cable for damage, replace it if there are signs of damage or ageing.
3. Do not use the lawnmower if the electric cables are damaged or worn
4. Immediately disconnect from the mains electricity supply if the cable is cut, or the insulation is damaged. Do not touch the electric cable until the electrical supply has been disconnected. Do not repair a cut or damaged cable. Replace it with a new one.
5. Your extension cable must be uncoiled or unwound, coiled or wound cables can overheat and reduce the efficiency of your mower.
6. Keep cable away from lawnmower, always work away from the power point mowing up and down, never in circles.
7. Do not pull cable around sharp objects.
8. Always switch off at the mains before disconnecting any plug, cable connector or extension cable.
9. Switch off, remove plug from mains and examine electric supply cable for damage or ageing **before** winding cable for storage. Do not repair a damaged cable, replace it with a new one. Use only Flymo replacement cable.
10. Always wind cable carefully, avoiding kinking.
11. Never carry the product by the cable.
12. Never pull on the cable to disconnect any of the plugs.
13. Use only on AC mains supply voltage shown on the product rating label.
14. Our products are double insulated to EN60335. Under no circumstance should an earth be connected to any part of the product.

## Preparation

1. While using your product always wear substantial footwear and long trousers.
2. Make sure the lawn is clear of sticks, stones, bones, wire and debris; they could be thrown by the blade.
3. Before using the machine and after any impact, check

- for signs of wear or damage and repair as necessary.
4. Replace worn or damaged blades together with their fixings in sets to preserve balance.

## Use

1. Use the lawnmower only in daylight or good artificial light.
2. Avoid operating your lawnmower in wet grass, where feasible.
3. Take care in wet grass, you may lose your footing.
4. On slopes, be extra careful of your footing and wear non-slip footwear.
5. Mow across the face of slopes, never up and down.
6. Exercise extreme caution when changing direction on slopes. Walk never run.
7. Mowing on banks and slopes can be dangerous. Do not mow on **banks** or **steep** slopes.
8. Do not walk backwards when mowing, you could trip.
9. Never cut grass by pulling the mower towards you.
10. Switch off before pushing the mower over surfaces other than grass.
11. Never operate the lawnmower with damaged guards or without guards in place.
12. Keep hands and feet away from the cutting means at all times and especially when switching on the motor.
13. Do not tilt lawnmower when the motor is running, except when starting and stopping. In this case, do not tilt more than absolutely necessary and lift only the part which is away from the operator. Always ensure that both hands are in the operating position before returning the appliance to the ground.
14. Never pick up or carry a mower when it is operating or still connected to the mains supply.
15. Remove the plug from the mains :
  - before leaving the mower unattended for any period;
  - before clearing a blockage;
  - before checking, cleaning or working on the appliance;
  - if you hit an object. Do not use your lawnmower until you are sure that the entire lawnmower is in a safe operating condition.;
  - if the lawnmower starts to vibrate abnormally. Check immediately. Excessive vibration can cause injury.

## Maintenance and storage

1. Keep all nuts, bolts and screws tight to be sure the lawnmower is in safe working condition.
2. Check the grassbox/grassbag frequently for wear or deterioration.
3. Replace worn or damaged parts for safety.
4. Only use the replacement blade, blade bolt, spacer and impeller specified for this product.
5. Be careful during adjustment of the lawnmower to prevent entrapment of the fingers between moving blades and fixed parts of the machine.

## CABLES

### IMPORTANT

- Use only 1.00mm<sup>2</sup> size cable up to 30 metres length maximum.

### Maximum rating :

- 1.00mm<sup>2</sup> size cable, 10 amps 250 volts AC.

### • THE ROLLER COMPACT 400/4000 IS SUPPLIED WITH AN ELECTRIC MAINS CABLE FITTED WITH A FEMALE CONNECTOR

1. Flymo Mains Cables and Extension Cables are available from your local Electrolux Outdoor Products Approved Service Centre.
2. Do not wire an extension cable directly to your product yourself. Please contact your local Electrolux Outdoor Products Approved Service Centre for further information on the connectors and kits available.
3. Only use extension cables specifically designed for outdoor use.

## CONNECTORS

### IMPORTANT

- Flymo connectors are suitable for use with 2 core cable only. Under no circumstances should these connectors be used for earthed products.
- All Flymo connectors and cables are of splashproof construction. They are not waterproof and must not be left outside permanently nor should they be submerged or immersed in water. Do not let cable lay or trail through pools of water or splashed with water from hose pipes.

## MAINS PLUG REPLACEMENT

### IMPORTANT

- **If the plug supplied is cut off it should be destroyed. There is an electric shock hazard if a cut off plug is inserted into a 13 amp socket.**

1. **No earth required.** Flymo products are double insulated to EN60335 and under no circumstances should an earth be connected to any part of the product.
2. **Ensure the mains voltage suits your product**
3. **IMPORTANT!**

The wires in the mains lead are coloured in accordance with the following code:

BLUE - NEUTRAL  
BROWN - LIVE

The wire which is coloured BLUE must be connected to the Terminal which is marked with the letter 'N' or coloured BLACK.

The wire which is coloured BROWN must be connected to the Terminal which is marked with the letter 'L' or coloured RED.

4. It is important that the outer sheath is clamped correctly into the 3-pin plug.
5. If in doubt consult your local Service Repairer or qualified electrician before the machine is used.
6. **A 13 Amp fuse must be fitted to the Mains Plug.**
7. The normal plug fuse and household fuse only protect the electrical equipment and are not a safeguard against electrocution.

## Assembly Instructions

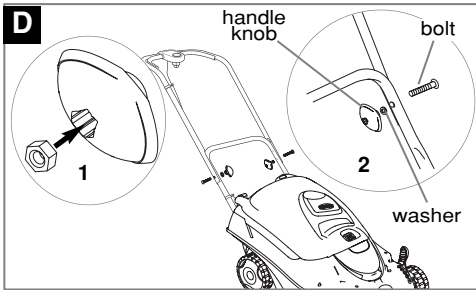
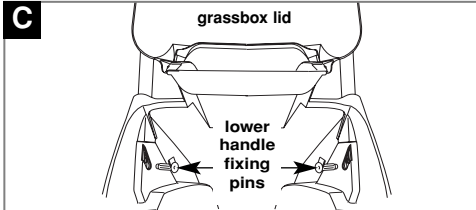
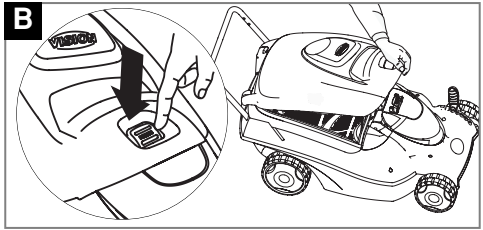
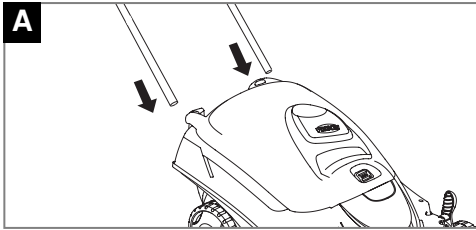

### Assembly of Lower Handles to Deck

1. Insert lower handle into holes in the deck (A).
2. Release the grassbox catch and lift the grassbox lid (B).
3. Rest the grassbox lid against the lower handle and remove the grassbox.
4. Push the lower handle into place ensuring that the holes in the lower handle are correctly located behind the holes in the deck.
5. Secure the lower handles to the inside of the deck with the lower handle fixing pins (C).
6. Ensure the fixing pins are securely located.
7. Should a problem occur when securing lower handle to deck, carefully lever fixing pins out of location and repeat steps 4 to 6 above.
8. Replace the grassbox and close the grassbox lid.

### Assembly of Upper Handles to Lower Handles.

- Ensure the upper handle is located correctly with the lock-off button on the switchbox uppermost
1. Insert the nut into the handle knob (D1).
  2. Ensure the upper handle and the lower handle are aligned correctly. (D2)
  3. Fit the bolts, washers and handle knobs. (D)
  4. Fit the cable to the handles with the clips provided. Make sure the cable is not trapped between the upper and lower handles.

## Cutting Height Adjustment

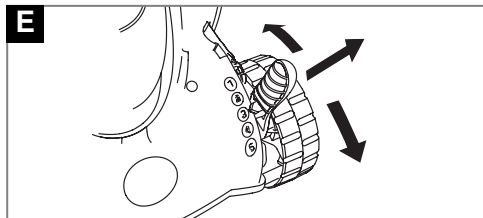

### Adjusting the cutting height

1. Lift the lever out of location and rotate to the desired position. (E)

### Heights of cut:-

**1 & 2 - low, 3 - medium, 4 & 5 - high**

## Removing, Emptying and Refitting the Grassbox

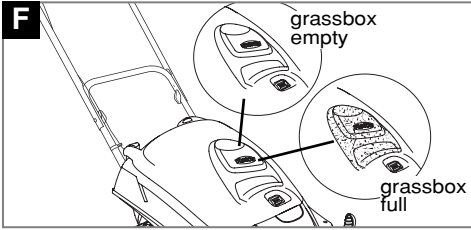

### Grassbox Full

- As the grassbox fills up, grass will be visible through the window in the lid (F).
- When the window is full it is time to empty the grassbox.

### Emptying the Grassbox

- **Stop the lawnmower, as described in 'To Stop your Lawnmower' and wait until the blade has stopped rotating, BEFORE lifting the grassbox lid.**
  1. Release grassbox catch and lift grassbox lid (B).**See Assembly Instructions.**
  2. Rest grassbox lid against lower handle and remove grassbox (G).
  3. Empty grassbox.
  4. Replace grassbox and close grassbox lid.

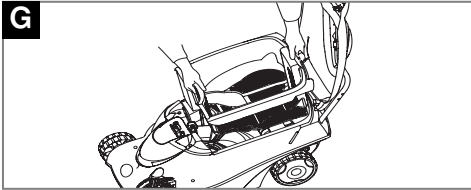

## Cut Out Device

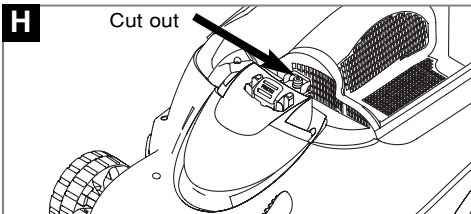

- **IMPORTANT**
- The Roller Compact is fitted with a cut-out device (H) which will prevent the lawnmower from being started until the grassbox lid is firmly close and clicked into place.
- Do not attempt to use your lawnmower without the grassbox in place or with the lid open.

## IMPORTANT INFORMATION

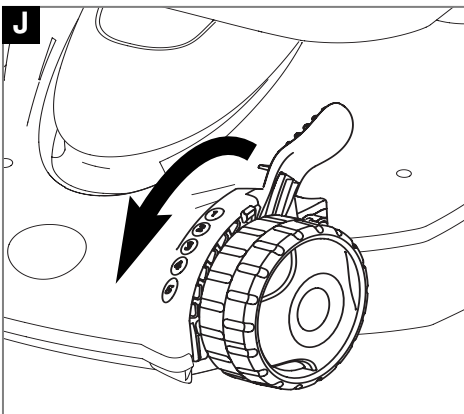

**When received from the Manufacturer, the front wheels are in a raised position.**  
**Do not switch on this product before removing from the raised position into a desired height of cut. (J)**

## Starting and Stopping

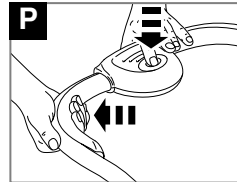
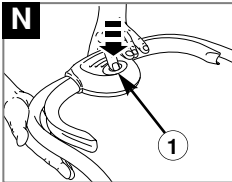
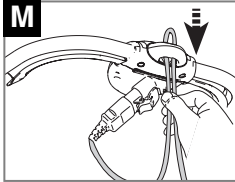
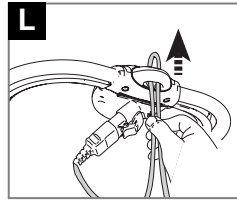
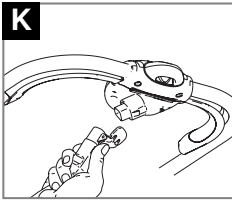

- **Important:- Your lawnmower will not start until the grassbox lid is firmly closed and clicked into place.**

### To Start your Lawnmower

1. Connect female extension cable connector to the back of the switchbox. **(K)**
2. Form loop in mains cable and push the loop through the slot as illustrated in picture **(L)**
3. To secure, position loop over the hook and pull the cable back through the slot as illustrated in picture **(M)**.
4. Connect plug to mains and switch on.
5. Tilt the handle downwards to slightly raise the front of the lawnmower and to reduce the risk of lawn damage whilst starting.

### The switchbox is provided with a lock-off button **(N1)** to prevent accidental starting.

6. Press and hold the lock-off button **(N)** on the switchbox, then squeeze one of the Start/Stop levers towards the upper handle **(P)**.
7. Continue to squeeze the start/stop lever towards the upper handle and release the lock-off button.
8. Lower the lawnmower to its proper operating position and commence mowing.

- **NOTE: There are two start/stop levers fitted. Either one can be used for starting the lawnmower.**
- **IMPORTANT: Do not use the start/stop levers intermittently**

### To Stop your Lawnmower

1. Release the pressure on the Start/Stop lever.

## How to Mow

1. Start mowing the edge of the lawn nearest to the power point so the cable is laid out on the lawn you have already cut.
2. Mow twice a week during the growing season, your lawn will suffer if more than a third of its length is cut at one time and this may also result in poor collection.

**Do Not Overload Your Mower:** Mowing long thick grass may cause the motor speed to drop, you will hear a change in the motor sound. If the motor speed drops you may overload your lawnmower which may cause damage. When mowing in long thick grass a first cut with the cutting height set higher will help reduce the load. See Cutting Height Adjustment.

## Removing and Fitting the Blade and Fan (Q)

Always handle the blade with care - sharp edges could cause injury. USE GLOVES.

### Removing the Blade and Fan

1. To remove the blade bolt, hold the fan firmly and, with the spanner provided, loosen the blade bolt by turning it anti-clockwise.
2. Remove the blade bolt, blade and fan from the pulley.
3. Inspect for damage and clean as necessary.

**Renew your metal blade after 50 hours mowing or 2 years whichever is the sooner - regardless of condition. If the blade is cracked or damaged replace it with a new one.**

### Fitting the Blade and Fan

1. Ensure the fan is located correctly.
2. Fit the blade to the fan.
3. Re-assemble blade bolt through blade and fan.
4. Hold the fan and tighten blade bolt firmly with the spanner provided. Do not over tighten.

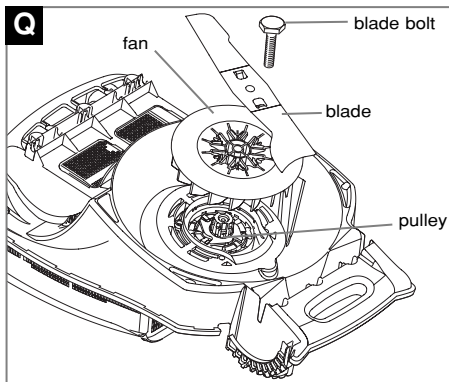

## Easi-Reel Cable Winder (Roller Compact 4000 only)

### Storing your cable in the Easi-Reel cable winder

1. Insert the female connector into the top of the cable winder (R1)
2. Place the cable under the cable guide (R2)
3. Turn the cable winder (R3) until all of the cable is wound in. (R4)

### Unwinding the cable before re-use

1. Pull the cable by the plug and unwind the cable fully.
- Ensure that the cable is released from the cable guide (R2) before using your machine.

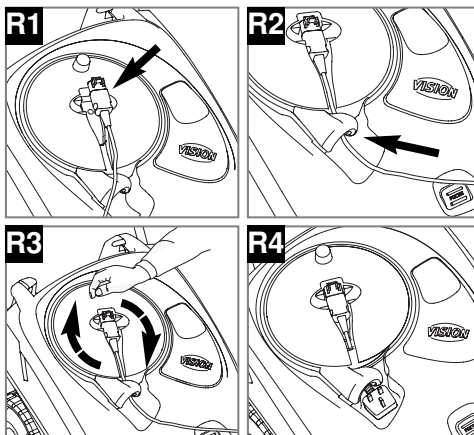

## Caring for your Lawnmower

### Cleaning (S)

#### • USE GLOVES

- **IMPORTANT:** It is very important that you keep your lawnmower clean. Grass clippings left in any of the air intakes or under the deck could become a potential fire hazard.
  - **IMPORTANT** Never use water for cleaning your lawnmower. Do not clean with chemicals, including petrol, or solvents - some can destroy critical plastic parts.
1. Remove grass from under the deck with the spanne/scrapper tool
  2. Remove the blade, **see Figure Q**, to gain access to the fan and clean with a soft brush.
  3. Raise the roller to its highest position, **see Cutting Height Adjustment**, and clean with a soft brush.
  4. Remove grass clippings from: all air intakes, wheels, height adjustment lever and grassbox with a soft brush.
  5. Clean the grassbox lid and the inside of the window with a soft brush.
  6. Thoroughly clean around the cut-out switch with a soft brush
  7. Wipe over the surface of your lawnmower with a dry cloth.

### Cleaning Easi-Reel cable winder (Roller Compact 4000 only)

1. Lift grassbox lid, squeeze together the two catches (**T**) and remove the cable winder.
2. Clean the cable winder and the area it was located with a soft brush (**V**)
3. Replace the cable winder, ensuring it clicks into place.

### At the End of the Mowing Season

1. Replace blade, bolts, nuts or screws, if necessary.
2. Clean your lawnmower thoroughly.
3. Ask your local Service Centre to clean the air filter thoroughly and carry out any service or repairs required.
4. Make sure that the electric cable is wound properly.

### Storing the lawnmower

The handles can be folded to take up the minimum of space.

- Loosen the handle knobs
- Fold the upper handle over the lawnmower.
- Ensure the switchbox cable is not trapped.
- Store in a dry place where your lawnmower is protected from damage.

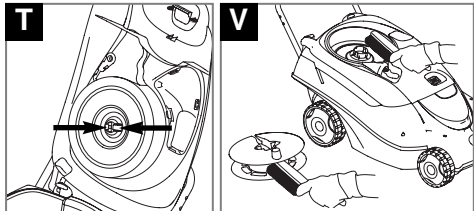
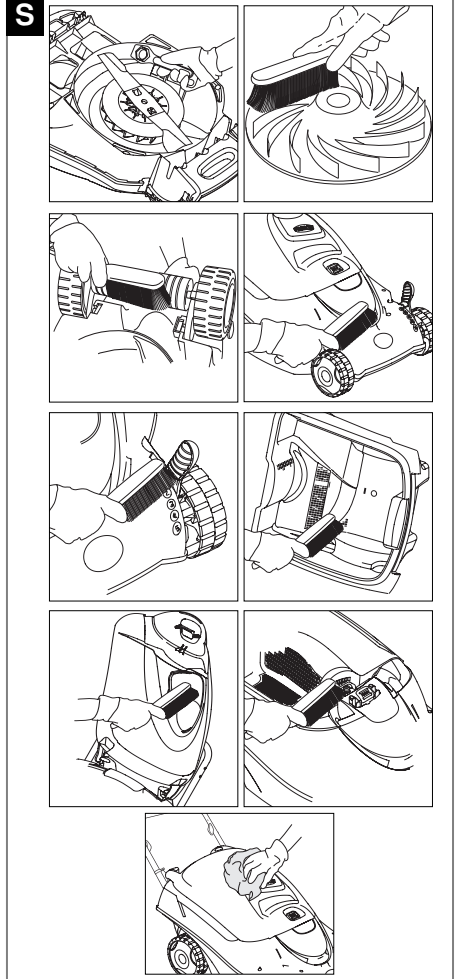



## Fault Finding Hints

### Fails to Operate

1. Is the correct Starting procedure being followed?  
See 'To Start your Lawnmower'.
2. Is the grassbox lid firmly closed?
3. Is the Power Turned On?
4. Check the fuse in the plug, if blown replace.
5. Fuse continues to blow?

**Immediately disconnect from the mains electricity supply and consult your local approved Electrolux Outdoor Products Service Centre.**

### Poor Grass Collection

1. Disconnect from the mains electricity supply.
2. Check that the grass chute and the underside of the deck are free from grass.
3. Raise to a higher height of cut. See Cutting Height Adjustment.
4. Clean Fan Blades.
5. If poor collection persists.

**Immediately disconnect from the mains electricity supply and consult your local approved Electrolux Outdoor Products Service Centre.**

### Lawnmower becomes heavy to push

1. Disconnect from the mains electricity supply.
2. In long grass or uneven ground, the height of cut should be raised to a higher position. See Cutting Height Adjustment
3. Check that the wheels and roller can rotate freely.
4. If problem persists?

**Immediately disconnect from the mains electricity supply and consult your local approved Electrolux Outdoor Products Service Centre.**

### Excessive Vibration

1. Disconnect from the mains electricity supply.
2. Check that the blade is fitted correctly?
3. If the blade is damaged or worn, replace it with a new one.
4. If vibration persists, turn the blade through 180° by first loosening the blade bolt, turning the blade and re-tightening the blade bolt.
5. If vibration persists?

**Immediately disconnect from the mains electricity supply and consult your local approved Electrolux Outdoor Products Service Centre.**

## Environmental Information

Electrolux Outdoor Products are manufactured under an Environmental Management System (ISO 14001) using, where practical, components manufactured in the most environmentally responsible manner, according to company procedures, and with the potential for recycling at the end of the products' life.

- Packaging is recyclable and plastic components have been labelled (where practical) for categorised recycling.
- Awareness of the environment must be considered when disposing of 'end-of-life' product.
- If necessary, contact your local authority for disposal information.

## Service Recommendations

1. We strongly recommend that your product is serviced at least every twelve months, more often in a professional application.
2. Always use genuine Flymo Spare Parts.
3. Prepacked spares are available from most Electrolux Outdoor Products stockists.
4. Your product is uniquely identified by a silver and black product rating label
5. If you have a problem with your machine contact your local Approved Service Centre ensuring you have full details of your product as described on the product rating label.
6. **Should it be necessary for work to be carried out by your**

**Service Centre, it is important to take your complete machine including cable and any extension cables used.**

A network of specialist dealers can be found in your local Yellow Pages. To obtain service on your Flymo product simply telephone or visit your local Service Centre.

Should you require service under the terms of our guarantee the Service Centre will require proof of purchase.

**All of the centres listed stock genuine Flymo Spare Parts.**

**NOTE: Our Service Repairers act on their own behalf and are not empowered to commit or legally bind Electrolux Outdoor Products in any manner whatsoever.**

## Guarantee & Guarantee Policy

If any part is found to be defective due to faulty manufacture within the guarantee period, Electrolux Outdoor Products, through its Authorised Service Repairers will effect the repair or replacement to the customer free of charge providing:

- (a) The fault is reported directly to the Authorised Repairer.
- (b) Proof of purchase is provided.
- (c) The fault is not caused by misuse, neglect or faulty adjustment by the user.
- (d) The failure has not occurred through fair wear and tear.
- (e) The machine has not been serviced or repaired, taken apart or tampered with by any person not authorised by Electrolux Outdoor Products.
- (f) The machine has not been used for hire.
- (g) The machine is owned by the original purchaser.
- (h) The machine has not been used outside of the country for which it was specified.
- (i) The machine has not been used commercially.
  - \* This guarantee is additional to, and in no way diminishes the customers statutory rights.

Failures due to the following are not covered, therefore it is important that you read the instructions contained in this Operator's Manual and understand how to operate and maintain your machine:

**Failures not covered by guarantee**

- Replacing worn or damaged blades
- Failures as a result of not reporting an initial fault.
- Failures as a result of sudden impact.
- Failures as a result of not using the product in accordance with the instructions and recommendations contained in this Operator's Manual.
- Machines used for hire are not covered by this guarantee.
- The following items listed are considered as wearing parts and their life is dependent on regular maintenance and are, therefore not normally subject to a valid warranty claim: Blade, Electric Mains cable, Belt

**Caution!**

Electrolux Outdoor Products does not accept liability under the warranty for defects caused in whole or part, directly or indirectly by the fitting of replacement parts or additional parts that are not either manufactured or approved by Electrolux Outdoor Products, or by the machine having been modified in any way.

## EC Declaration of Conformity

I, the undersigned M. Bowden of Electrolux Outdoor Products, Aycliffe Industrial Park, **NEWTON AYCLIFFE**, Co. Durham. DL5 6UP. Certify that the product:-

Category..... **Electric Wheeled Rotary**  
 Make..... **Electrolux Outdoor Products**  
 Conforms to the specifications of Directive 2000/14/EEC

Type of Cutting Device.... **Rotary Blade**  
 Identification of Series.....**See Product Rating Label**  
 Conformity Assessment Procedure....**ANNEX VI**  
 Notified Body.....**J.T.S., Cleeve Road, Leatherhead, Surrey, KT27 7SB England**  
 Other Directives:-.....**98/37/EEC, 89/336/EEC, 73/23/EEC & applicable standards:- EN60555-2:1987, EN60555-3:1987, EN55014:1993, EN55014:1995, EN836:1997, IEC335-1:1991, IEC335-2-77:1996**

I, the undersigned M. Bowden of Electrolux Outdoor Products, Aycliffe Industrial Park, **NEWTON AYCLIFFE**, Co. Durham. DL5 6UP Certify that a sample of the above product has been tested using directive 81/1051/EEC as a guide. The maximum A-weighted sound pressure level recorded at operator position under free field semi anechoic chamber conditions was :-

Type.....	<b>RCV400/4000</b>
Width of Cut.....	<b>40 cm</b>
Speed of Rotation of Cutting Device.....	<b>3,700 RPM</b>
Guaranteed sound power level.....	<b>95 dB (A)</b>
Measured Sound Power Level.....	<b>93 dB (A)</b>
Level.....	<b>81.9 dB (A)</b>
Value.....	<b>3.11 m/s<sup>2</sup></b>
Weight.....	<b>15.3 kg</b>

I, the undersigned M. Bowden of Electrolux Outdoor Products, Aycliffe Industrial Park, **NEWTON AYCLIFFE**, Co. Durham. DL5 6UP Certify that a sample of the above product has been tested using ISO 5349 as a guide. The maximum weighted root mean square value of vibration recorded at operator's hand position was:-

*M. Bowden*  
 Newton Aycliffe,  
 M. Bowden,  
 Research & Development  
 Director

Electrolux Outdoor Products  
 Aycliffe Industrial Park  
 NEWTON AYCLIFFE  
 Co. Durham DL5 6UP  
**ENGLAND**

Telephone - (00) 44 1325 300303 Fax - (00) 44 1325 310339

Our policy of continuous improvement means that the specification of products may be altered from time to time without prior notice. Electrolux Outdoor Products manufacture products for a number of well known brands under various registered patents, designs and trademarks in several countries.

© Electrolux Outdoor Products Ltd. Registered Office, Electrolux Works, Oakley Road, Luton LU4 9QQ  
 Registered number 974979 England



**The Electrolux Group. The world's No. 1 choice.**

The Electrolux Group is the world's largest producer of powered appliances for kitchen, cleaning and outdoor use. More than 55 million Electrolux Group products (such as refrigerators, cookers, washing machines, vacuum cleaners, chain saws and lawn mowers) are sold each year to a value of approx. USD 14 billion in more than 150 countries around the world.

